



20
25

TREKBOOK |



KOMPERDELL



06

WE ARE KOMPERDELL

our Mission
Zero Waste



14

TRAILRUNNING

FXP Carbon "The Erlkönig"
FXP Carbon Ultra
FXP Composite Trail



18

TREKKING

Trekking FX Lite
Women Edition
Carbon Cloud
Carbon Pro/Evo
Titanal Explorer
Trekking Aluminum
Trekking Junior
Trekking Single Staff
Walking Single Staff



40

NORDIC WALKING

Nordic Walking Carbon
Nordic Walking Vario



48

UNIQUE SERVICE

3 year free repair service



50

ACCESSORIES

spare parts
POS Material



WE DO IT **OUR*** WAY

* PRIMARY
SUSTAINABLE



OUR MISSION

100%
*

* HEART AND
PASSION



* MADE IN
AUSTRIA

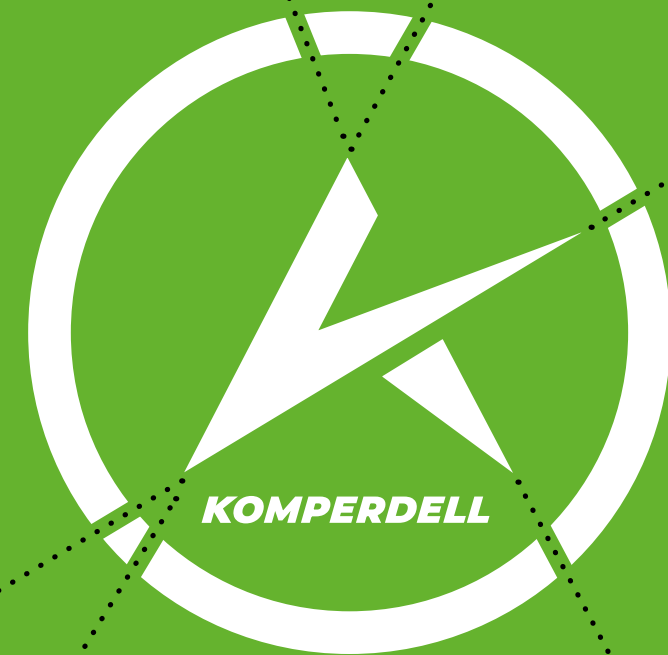

KOMPERDELL

* ECO BUT
LOGICAL



* WE KNOW
HOW



* SERVICE WITH
GUARANTEE



PRIMARYLY SUSTAINABLE

→ PIONEER IN SUSTAINABILITY

We live, work and think according to our very own values. And we have been doing so for over 40 years – long before the term „sustainability“ became an integral part of our vocabulary.

Because our world is really important to us, because we bear responsibility – not only for ourselves, but also for future generations and not least because we love the natural environment in which we live, it is important to us to avoid waste and use our resources sparingly. For us, sustainable action is therefore not an fundamental principle, but a self-evident need!

→ ECO BUT LOGICAL

We are known for our commitment to high functionality, robustness and stability of our products.

It is therefore essential for us that the ecological aspect never comes at the expense of product quality, but that both must work hand in hand – logically!

→ GREEN BUT HONEST

We do not invest in the purchase of certificates that promote greenwashing.

We have therefore developed our new Zero Waste Program to reflect our complete ecological self-image as transparently as possible.



**REDUCE
+ REPAIR
RECYCLE
= ZERO WASTE**



ZERO WASTE

"Anyone who can put 'Made in Austria' on their products is already doing a lot right when it comes to sustainability.

The fact that Komperdell offers a comprehensive repair and recycle service in addition to its zero-waste programme and resource-saving production methods is worthy of an ISPO Award."

Jury Statement, ISPO Award



ISPO
AWARD
2024



WINNER

Foam grip
We recycle every single gram of waste in our foam grip production. More than **40 tons** recycled annually.

Strap
Set up in the weaving process creates considerable waste. Today every single piece of waste is recycled directly in the factory. **6 tons** of waste recycled annually.

Waterbased colors
environmentally friendly due to reduced emissions.

Powerlock
Closure made from 100% recycled aluminum.

7075 Aluminum shaft
Made of 100 % recycled aluminum. Every single gram of waste in our production gets recycled. More than **12 tons** annually. This equals more than **850.000 aluminum cans**.

Tip & Basket
Every single gram of waste in production gets recycled directly in the factory.



"Sustainability is not just a slogan, it's a core belief of our company."

Thomas Roiser, CEO KOMPERDELL



ZERO WASTE HOW IT WORKS



RECYCLE

Green, but honest – zero waste in production
We do not believe in labels and certificates. Our approach to a more sustainable production is simple and honest. Our goal is to produce our poles without a single gram of waste and with the smallest possible environmental impact.



REPAIR

Repairing instead of buying new
We launched our 3-year free repair service more than 15 years ago. No questions asked – no matter if it is our customers' fault or ours. Our service is part of our belief that quality products must be backed by outstanding service.



RECYCLE

Eco, but logical
If your pole can no longer be repaired, please send it back to us. We have created a dedicated recycling department as we are best suited to separate and recycle the materials in a pole.



From left to right
Thomas, Max und Raimund – a core part of the development team at Komperdell



FXP CARBON

"The wow effect in every race! As soon as I was allowed to test the prototype, I knew I had to have this stylish pole as quickly as possible! Super light, highly functional, handling in seconds - exactly what I have always imagined."

Jens Kramer, professional trail runner

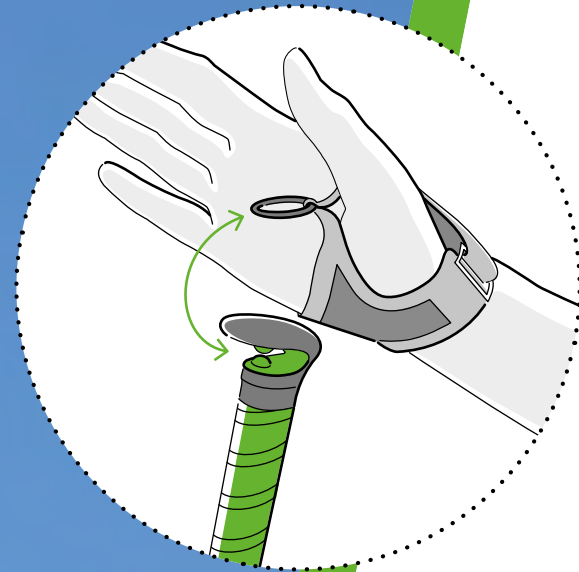
**Easy handling**

Simply put the rubber over the handle head. Thread, hook in, grip the handle and off you go!

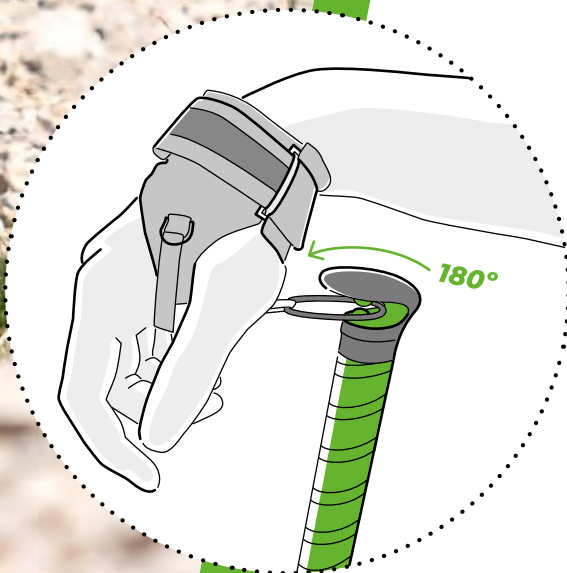
**Decoupling made easy**

Pull your hand 180° forward over the handle head. Release the rubber with a short pull.

FXP CARBON

MINIMALISTIC. PURISTIC. EFFICIENT.

**BRAND
NEW**

+ ADVANTAGES AT A GLANCE

- + style your pole: choose from different non-slip grip tapes to style your pole just as the whim takes you
- + our innovative Fly-strap-system guarantees easy handling and maximum power transmission
- + innovative technology in the grip head enables use in seconds by simply hooking the straps
- + extremely small packed size
- + immediately ready to use thanks to our award-winning self-deploying FXP mechanism

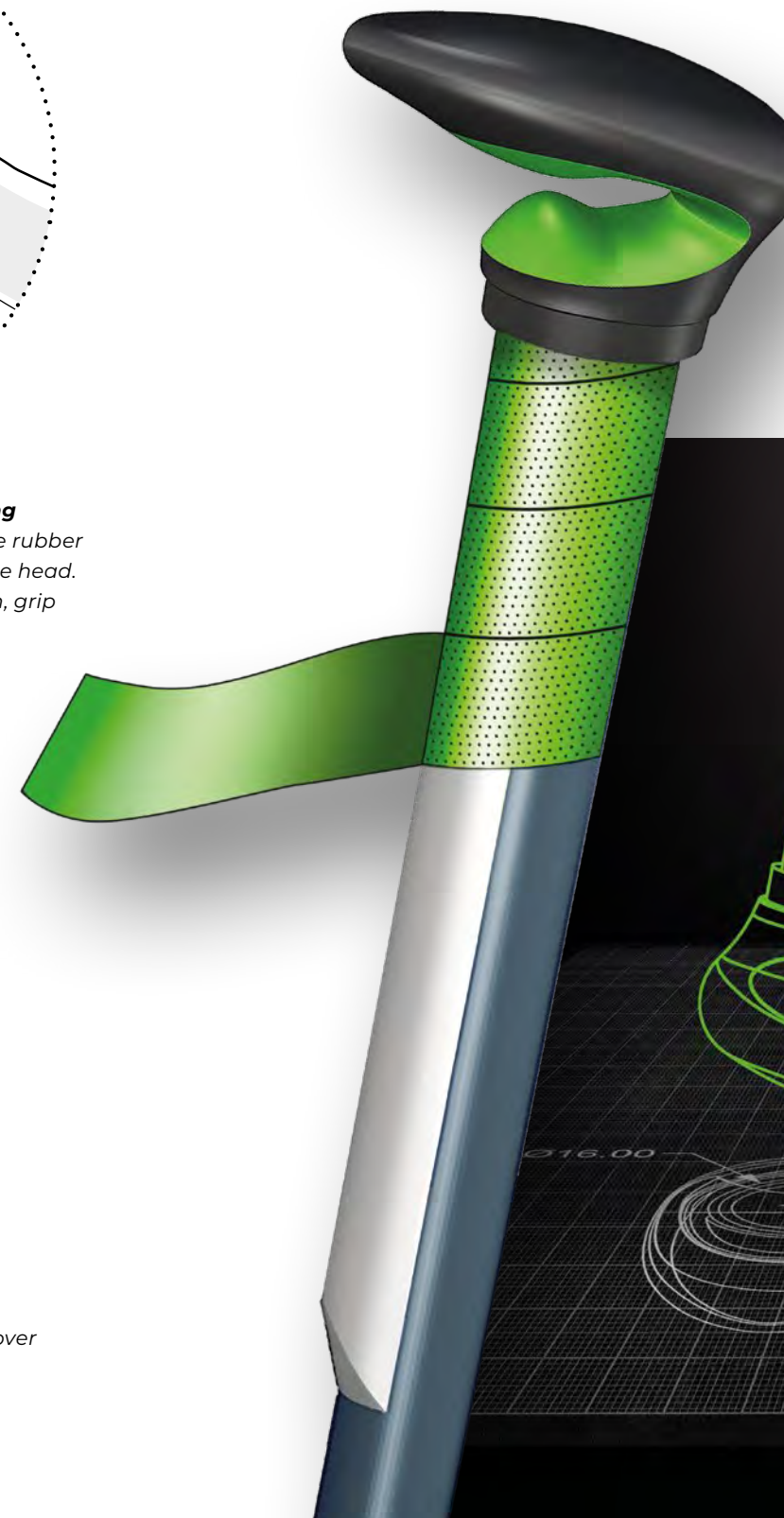

DEVELOPMENT **KOMPERDELL**

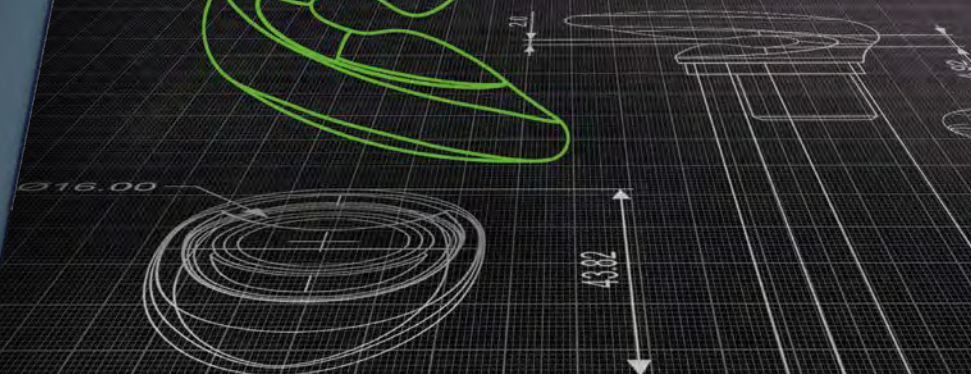

FXP CARBON ULTRA

The Carbon FXP trail running poles set new standards in terms of performance, comfort and design. Completely rethought and reduced to the essentials - exactly what performance-oriented trail runners with highest demands are looking for.

**The combination makes the difference:**

Only 14mm shaft diameter and the self-deploying FXP mechanism guarantee a smooth handling when pulling the poles out of the quiver. Ready to use in a matter of seconds.

+ ADVANTAGES AT A GLANCE

- + particularly small pack size, fits perfectly in conventional quivers
- + the minimized shape saves weight and ensures agile handling
- + our innovative Fly strap system guarantees easy handling and maximum power transmission
- + thanks to the patented FXP folding mechanism, the pole unfolds completely by itself when released



CARBON

FXP ULTRA

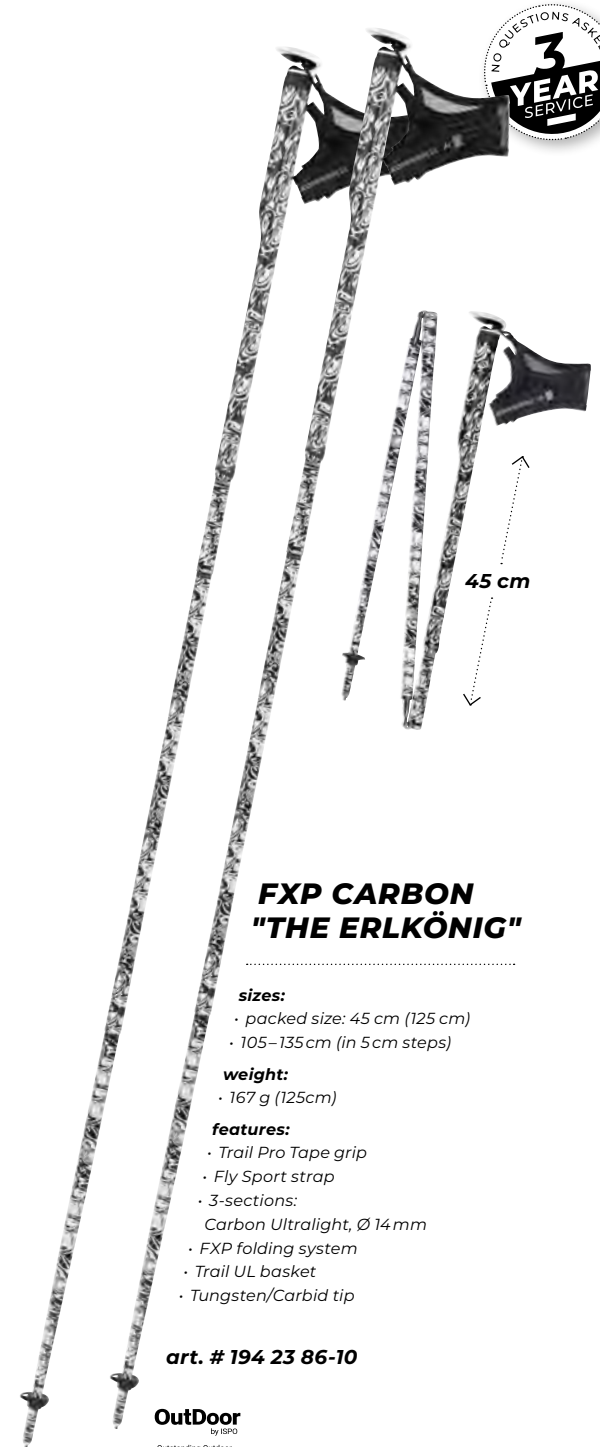
+ OPTIONALLY AVAILABLE**FXP CARBON "THE ERLKÖNIG"**

sizes:
 • packed size: 45 cm (125 cm)
 • 105-135 cm (in 5 cm steps)

weight:
 • 167 g (125cm)

features:
 • Trail Pro Tape grip
 • Fly Sport strap
 • 3-sections:
 Carbon Ultralight, Ø 14mm
 • FXP folding system
 • Trail UL basket
 • Tungsten/Carbid tip

art. # 194 23 86-10

OutDoor
 by HSPD
 Outstanding Outdoor
 by HSPD



45 cm

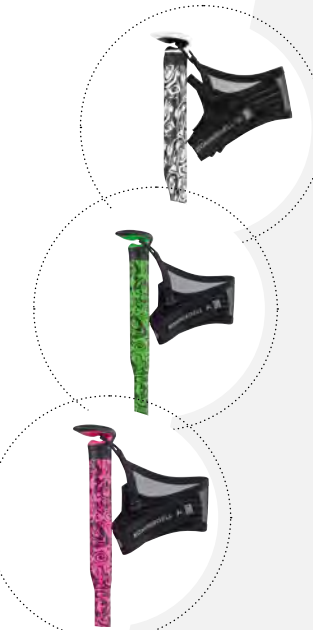

FXP Tape, pre-packed

art. # 8292-925
 Erbkönig Original

art. # 8280-925
 Erbkönig Green

art. # 8282-925
 Erbkönig Pink



Fly Loop Strap
 pre-packed

art. # 7031-925

**FXP CARBON ULTRA**
Green/Pink

sizes:
 • packed size: 45 cm (125 cm)
 • 105-135 cm (in 5 cm steps)

weight:
 • 167 g (125cm)

features:
 • Trail Pro Tape grip
 • 1 spare tape included (green/pink)
 • Fly Sport strap
 • 3-sections:
 Carbon Ultralight, Ø 14 mm
 • FXP folding system
 • Trail UL basket
 • Tungsten/Carbid tip

art. # 194 23 74-48

OutDoor
 by HSPD

Outstanding Outdoor
 by HSPD



COMPOSITE FXP TRAIL

ACCESSORIES

NORDIC WALKING

TREKKING

TRAILRUNNING



PIMP YOUR POLE!



spare tape included

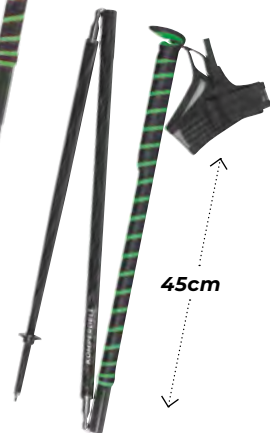

45cm

FXP COMPOSITE TRAIL Green

sizes:
• packed size: 45 cm (125 cm)
• 105–135 cm (in 5 cm steps)

weight:
• 199 g (125 cm)

features:
• Trail Pro Tape grip
• 1 spare tape included (solid green)
• Fly Sport strap
• 3-sections:
Carbon composite, Ø 16 mm
• FXP folding system
• Trail UL basket
• Tungsten/Carbid tip

art. # 194 23 76-10

OutDoor
by ISPO
Outstanding Outdoor

+ OPTIONALLY AVAILABLE



Fly Loop Schlaufe
pre-packed
art. # 7031-925



PIMP YOUR POLE!



spare tape included



45 cm

FXP COMPOSITE TRAIL Blue

sizes:
• packed size: 45 cm (125 cm)
• 105–135 cm (in 5 cm steps)

weight:
• 199 g (125 cm)

features:
• Trail Pro Tape grip
• 1 spare tape included (solid blue)
• Fly Sport strap
• 3-sections:
Carbon Composite, Ø 16 mm
• FXP Folding system
• Trail UL basket
• Tungsten/Carbid tip

art. # 194 23 78-10

OutDoor
by ISPO
Outstanding Outdoor

+ OPTIONALLY AVAILABLE

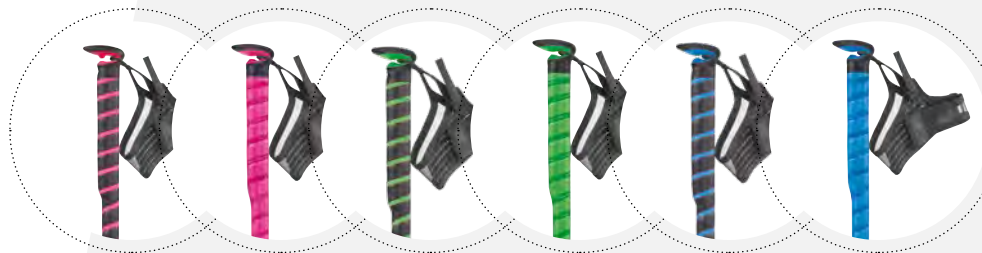

FXP Tape, pre-packed

- art. # 8285-925 Black Pink Striped
- art. # 8288-925 Solid Pink
- art. # 8286-925 Black Green Striped
- art. # 8289-925 Solid Green
- art. # 8287-925 Black Blue Striped
- art. # 8290-925 Solid Blue



spare tape included



45 cm

FXP COMPOSITE TRAIL Pink

sizes:
• packed size: 45 cm (125 cm)
• 105–135 cm (in 5 cm steps)

weight:
• 199 g (125 cm)

features:
• Trail Pro Tape grip
• 1 spare tape included (solid pink)
• Fly Sport strap
• 3-sections:
Carbon Composite, Ø 16 mm
• FXP folding system
• Trail UL basket
• Tungsten/Carbid tip

art. # 194 23 77-10

OutDoor
by ISPO
Outstanding Outdoor

ACCESSORIES

NORDIC WALKING

TREKKING

TRAILRUNNING

TREKKING

FX LITE



+ ADVANTAGES AT A GLANCE

- + Unfolds by itself – simply click and fix
- + As robust as a conventional telescopic pole due to multiple reinforced shafts
- + Easy and safe use
- + Foldable with press button



FX LITE CARBON Summit Vario

Sizes:
 • packed size: 40 cm
 • adjustable from 115–135 cm

Weight:
 • 236 g

Features:
 • Trek Pro 245 cork grip
 • Comfort Padded strap
 • 4-sections:
 Carbon, Ø 18/16 mm
 • Powerlock 3.0 locking mechanism
 • FX LITE folding mechanism
 • FXP UL VARIO basket
 • flex carbide tip

art. # 194 23 82-10



FX LITE CARBON Summit Vario Compact

Sizes:
 • packed size: 40 cm
 • adjustable from 105–125 cm

Weight:
 • 227 g

Features:
 • Trek Pro 245 cork grip
 • Comfort Padded strap
 • 4-sections:
 Carbon, Ø 18/16 mm
 • Powerlock 3.0 locking mechanism
 • FX LITE folding mechanism
 • FXP UL VARIO basket
 • flex carbide tip

art. # 194 23 83-10



TREKking

FX LITE



FX LITE CARBON Approach Vario

- Sizes:**
- packed size: 40 cm
 - adjustable from 115–135 cm
- Weight:**
- 241 g
- Features:**
- Trek Pro 245 Foam grip
 - Comfort Padded strap
 - 4-sections: Aluminum 7075-T6, Ø 18 mm, Carbon, Ø 16 mm
 - Powerlock 3.0 locking mechanism
 - FX Lite folding mechanism
 - FXP UL VARIO basket
 - flex carbide tip

art. # 194 23 84-10



FX LITE CARBON Approach Vario Compact

- Sizes:**
- packed size: 38 cm
 - adjustable from 105–125 cm
- Weight:**
- 230 g
- Features:**
- Trek Pro 245 Foam grip
 - Comfort Padded strap
 - 4-sections: Aluminum 7075-T6, Ø 18 mm, Carbon, Ø 16 mm
 - Powerlock 3.0 locking mechanism
 - FX Lite folding mechanism
 - FXP UL VARIO basket
 - flex carbide tip

art. # 194 23 85-10



FX LITE TI Vario

- Sizes:**
- packed size: 40 cm
 - adjustable from 115–135 cm
- Weight:**
- 273 g
- Features:**
- Trail Pro 245 Foam grip
 - Comfort Padded strap
 - 4-sections: Aluminum 7075-T6, Ø 18 mm, Carbon, Ø 16 mm
 - Powerlock 3.0 locking mechanism
 - FX LITE folding mechanism
 - FXP UL VARIO basket
 - flex carbide tip

art. # 194 23 70-10



FX LITE TI Vario Compact

- Sizes:**
- packed size: 40 cm
 - adjustable from 105–125 cm
- Weight:**
- 262 g
- Features:**
- Trail Pro 245 Foam grip
 - Comfort Padded strap
 - 4-sections: Aluminum 7075-T6, Ø 18 mm, Carbon, Ø 16 mm
 - FX LITE folding mechanism
 - FXP UL VARIO basket
 - flex carbide tip

art. # 194 23 71-10



WOMEN EDITION

Ladies' choice: a superior companion for your outdoor activities - trekking poles from our women edition. A perfect mix of design, fashion and highest functionality combined with lightness and a small packing size. A pole that offers all you could wish for!



CALIMA Carbon Cloud

Sizes:
 · packed size: 57 cm
 · adjustable from 90–120 cm

Weight:
 · 179 g

Features:
 · Trek Pro 280 cork grip
 · Air Padded strap
 · 3-sections:
 Carbon Cloud, Ø 18/16/14 mm
 · Powerlock 3.0 locking mechanism
 · Mini UL Vario basket
 · flex carbide tip

art. # 175 23 58-10



WOMEN EDITION



BOREA Carbon Pro

Sizes:
 · packed size: 57 cm
 · adjustable from 90–120 cm

Weight:
 · 212 g

Features:
 · Trek Pro 280 cork grip
 · Air Padded strap
 · 3-sections:
 top part: Carbon, Ø 18 mm
 middle part: Carbon, Ø 16 mm
 lower part: Titanal .HF, Ø 14 mm
 · Powerlock 3.0 locking mechanism
 · Mini UL Vario basket
 · flex carbide tip

art. # 175 23 59-10



TRAMONTANA TI

Sizes:
 · packed size: 57 cm
 · adjustable from 90–120 cm

Weight:
 · 223 g

Features:
 · Trek Pro 280 Foam grip
 · Comfort Padded strap
 · 3-sections:
 Aluminum 7075-T6, Ø 18/16/14 mm
 · Powerlock 3.0 locking mechanism
 · Mini UL Vario basket
 · flex carbide tip

art. # 174 23 59-55



CARBON CLOUD

Light as a cloud – our Carbon Cloud trekking poles are a world champion in lightness and master every challenge. If you test them once, you will be on cloud nine, or rather on Cloud Zero.

**CARBON CLOUD**
Zero

- Sizes:**
- packed size: 67 cm
 - adjustable from 105–140 cm

- Weight:**
- 187 g

- Features:**
- Trek Pro 280 cork grip
 - Air Padded strap
 - 3-sections: Carbon Cloud, Ø 18/16/14 mm
 - Powerlock 3.0 locking mechanism
 - Mini UL Vario basket
 - flex carbide tip

art. # 175 23 85-10

ISPO
AWARD
2024
WINNER

CARBON
CLOUD**POWERLOCK 3.0**

200 kg vertical loading capacity – our Powerlock 3.0 offers by far the strongest holding force. The latest product update is consistently made of forged aluminum – unique and almost indestructible. **More power is not possible.**

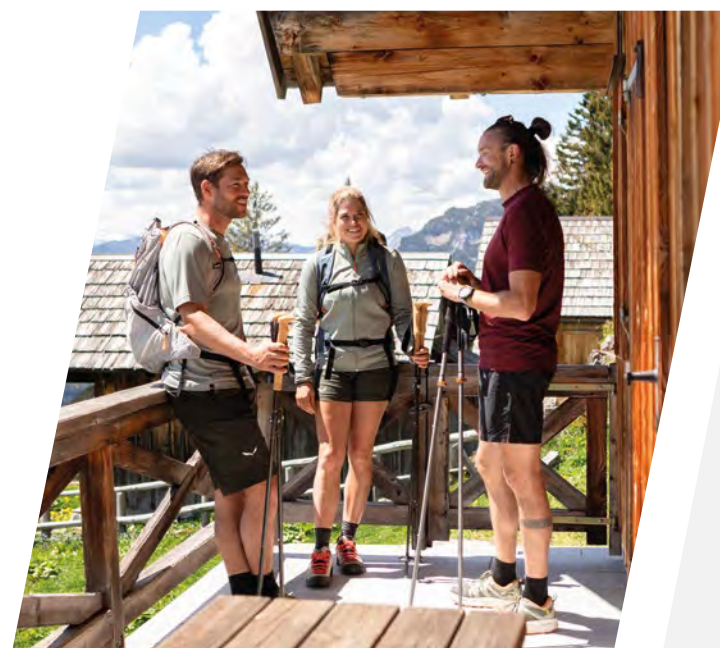
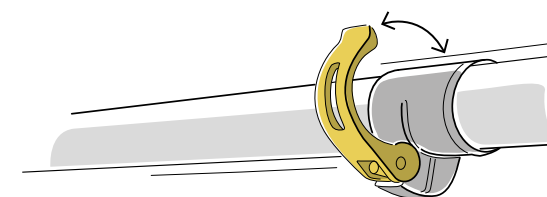
**CARBON CLOUD**
Zero Compact

- Sizes:**
- packed size: 57 cm
 - adjustable from 90–120 cm

- Weight:**
- 175 g

- Features:**
- Trek Pro 280 cork grip
 - Air Padded strap
 - 3-sections: Carbon Cloud, Ø 18/16/14 mm
 - Powerlock 3.0 locking mechanism
 - Mini UL Vario basket
 - flex carbide tip

art. # 175 23 86-10

ISPO
AWARD
2024
WINNER

CARBON PRO/EVO



57 cm

CARBON PRO Zero Compact

- Sizes:**
- packed size: 57 cm
 - adjustable from 90–120 cm

Weight:

- 201 g

Features:

- Trek Pro 280 Foam grip
- Comfort Padded strap
- 3-sections:
 - top part: Carbon, Ø 18 mm
 - middle part: Carbon, Ø 16 mm
 - lower part: Titanal.HF, Ø 14 mm
- Powerlock 3.0 locking mechanism
- Mini UL Vario basket
- flex carbide tip

art. # 175 23 88-10



57 cm

CARBON EVO Zero Compact

- Sizes:**
- packed size: 57 cm
 - adjustable from 90–120 cm

Weight:

- 193 g

Features:

- Trek Foam Comfort grip
- Comfort Padded strap
- 3-sections:
 - top part: Carbon, Ø 18 mm
 - middle part: Carbon, Ø 16 mm
 - lower part: Titanal HF, Ø 14 mm
- Powerlock 3.0 locking mechanism
- Mini UL Vario basket
- flex carbide tip

art. # 175 23 90-10



67 cm

CARBON PRO Zero

- Sizes:**
- packed size: 67 cm
 - adjustable from 105–140 cm

Weight:

- 218 g

Features:

- Trek Pro 280 Foam grip
- Comfort Padded strap
- 3-sections:
 - top part: Carbon, Ø 18 mm
 - middle part: Carbon, Ø 16 mm
 - lower part: Titanal.HF, Ø 14 mm
- Powerlock 3.0 locking mechanism
- Mini UL Vario basket
- flex carbide tip

art. # 175 23 87-10



67 cm

CARBON EVO Zero

- Sizes:**
- packed size: 67 cm
 - adjustable from 105–140 cm

Weight:

- 213 g

Features:

- Trek Foam Comfort grip
- Comfort Padded strap
- 3-sections:
 - top part: Carbon, Ø 18 mm
 - middle part: Carbon, Ø 16 mm
 - lower part: Titanal.HF, Ø 14 mm
- Powerlock 3.0 locking mechanism
- Mini UL Vario basket
- flex carbide tip

art. # 175 23 89-10



POWERLOCK 3.0

“The strongest lock and best reliability I have ever seen in a locking mechanism. An indispensable companion especially in demanding terrain – simply outstanding technology from Komperdell.”

Gerlinde Kaltenbrunner, professional mountaineer



**Easy handling
guarantees fast
adjustability in
extreme situations.**

POWERLOCK 3.0

THE NEW GENERATION

+ ADVANTAGES AT A GLANCE

- + Best holding power (up to 200 kg)
- + 100% made of forged aluminum (warrantor for a long lifetime)
- + Highest pressure load in comparative tests
- + 3-year free repair service on all parts



DEVELOPMENT **KOMPERDELL**

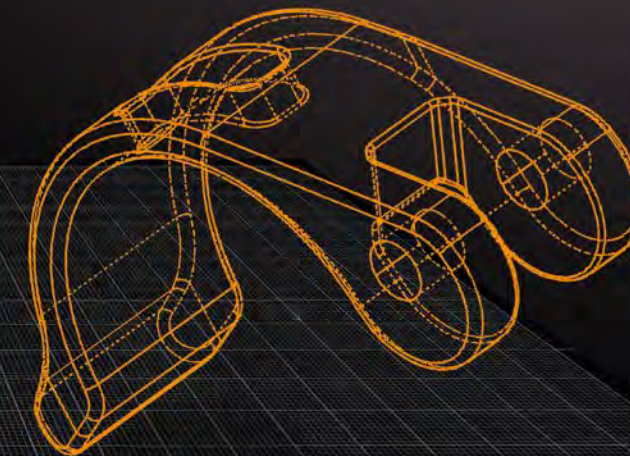
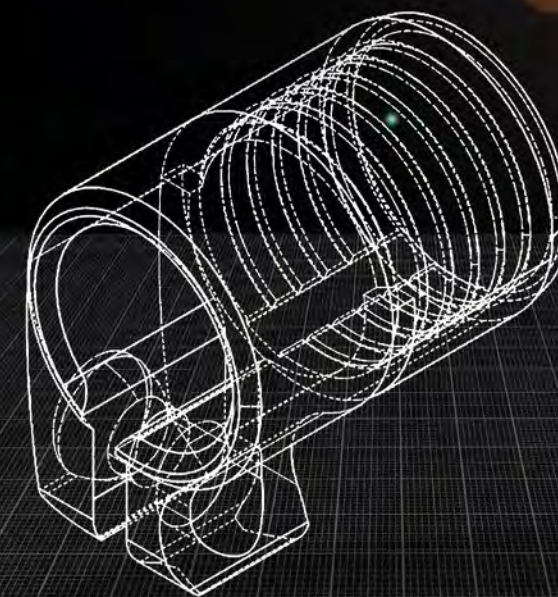

TITANAL EXPLORER



EXPLORER Zero Cork Compact

Sizes:
• packed size: 57 cm
• adjustable from 90–120 cm

Weight:
• 226 g

Features:
• Trek Pro 280 cork grip
• Comfort Padded strap
• 3-sections:
Aluminum 7075-T6, Ø 18/16/14 mm
• Powerlock 3.0 locking mechanism
• Mini UL Vario basket
• flex carbide tip

art. # 174 23 61-10

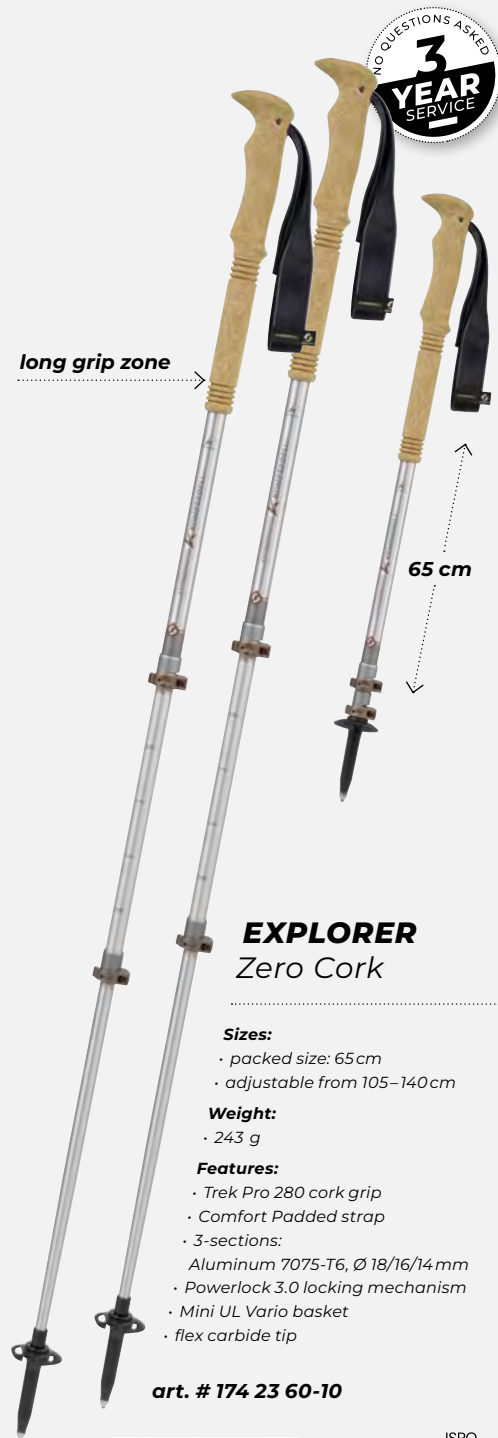

EXPLORER Zero Cork

Sizes:
• packed size: 65 cm
• adjustable from 105–140 cm

Weight:
• 243 g

Features:
• Trek Pro 280 cork grip
• Comfort Padded strap
• 3-sections:
Aluminum 7075-T6, Ø 18/16/14 mm
• Powerlock 3.0 locking mechanism
• Mini UL Vario basket
• flex carbide tip

art. # 174 23 60-10

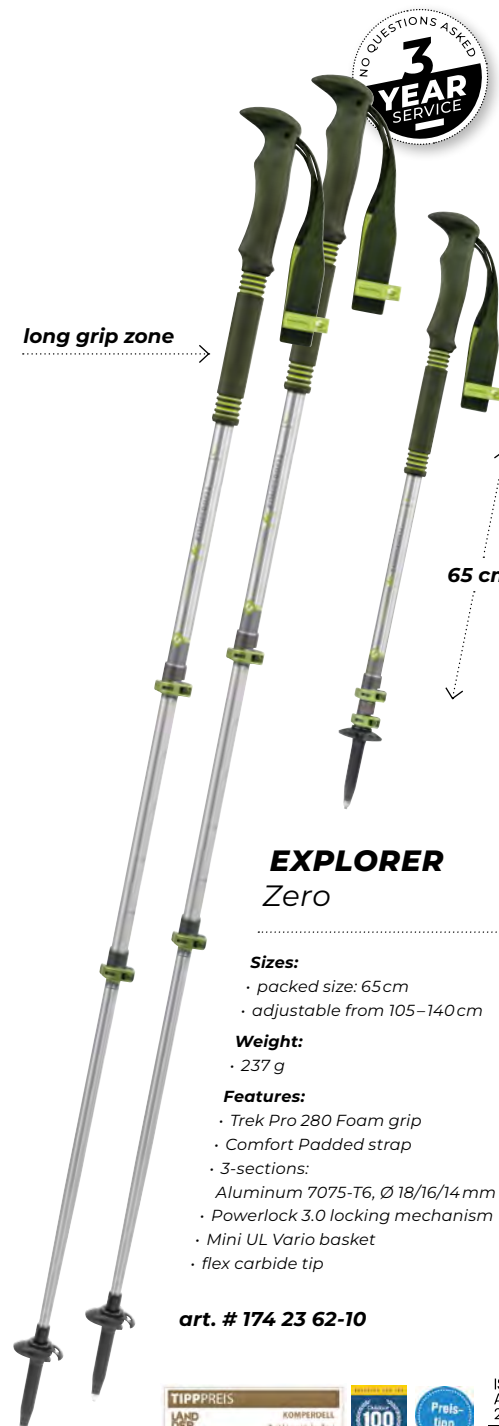

EXPLORER Zero

Sizes:
• packed size: 65 cm
• adjustable from 105–140 cm

Weight:
• 237 g

Features:
• Trek Pro 280 Foam grip
• Comfort Padded strap
• 3-sections:
Aluminum 7075-T6, Ø 18/16/14 mm
• Powerlock 3.0 locking mechanism
• Mini UL Vario basket
• flex carbide tip

art. # 174 23 62-10



EXPLORER Zero Compact

Sizes:
• packed size: 57 cm
• adjustable from 90–120 cm

Weight:
• 223 g

Features:
• Trek Pro 280 Foam grip
• Comfort Padded strap
• 3-sections:
Aluminum 7075-T6, Ø 18/16/14 mm
• Powerlock 3.0 locking mechanism
• Mini UL Vario basket
• flex carbide tip

art. # 174 23 63-10





TREKKING ALUMINUM



Cork Grip
comfortable grip feeling



64 cm

RIDGEHIKER Zero

Sizes:
· packed size: 64 cm
· adjustable from 105-140 cm

Weight:
· 269 g

Features:
· Trek cork Comfort grip
· Comfort Padded strap
· 3-sections:
Aluminum 7075-T6, Ø 18/16/14 mm
· Powerlock 3.0 locking mechanism
· Mini UL Vario basket
· flex carbide tip

art. # 174 23 64-37



57 cm
7 cm smaller packed size

RIDGEHIKER Zero Compact

Sizes:
· packed size: 57 cm
· adjustable from 90-120 cm

Weight:
· 252 g

Features:
· Trek cork Comfort grip
· Comfort Padded strap
· 3-sections:
Aluminum 7075-T6, Ø 18/16/14 mm
· Powerlock 3.0 locking mechanism
· Mini UL Vario basket
· flex carbide tip

art. # 174 23 65-29



TREKKING ALUMINUM



TRAILMASTER Zero Compact

- Sizes:**
- packed size: 57 cm
 - adjustable from 90–120 cm

Weight:

• 216 g

Features:

- Trek Foam Comfort grip
- Comfort Padded strap
- 3-sections: Aluminum 7075-T6, Ø 18/16/14 mm
- Powerlock 3.0 locking mechanism
- Mini UL Vario basket
- flex carbide tip

art. # 174 23 67-33

ISPO AWARD 2024 WINNER



TRAILMASTER Zero

- Sizes:**
- packed size: 64 cm
 - adjustable from 105–140 cm

Weight:

• 235g

Features:

- Trek Foam Comfort grip
- Comfort Padded strap
- 3-sections: Aluminum 7075-T6, Ø 18/16/14 mm
- Powerlock 3.0 locking mechanism
- Mini UL Vario basket
- flex carbide tip

art. # 174 23 66-06

ISPO AWARD 2024 WINNER



TRAILHUNTER Zero

- Sizes:**
- packed size: 65 cm
 - adjustable from 105–140 cm

Weight:

• 212g

Features:

- Trek Foam Comfort grip
- Comfort Padded strap
- 3-sections: Aluminum 7075-T6, Ø 18/16/14 mm
- Twist Lock locking mechanism
- Mini UL Vario basket
- flex carbide tip

art. # 174 23 69-21

ISPO AWARD 2024 WINNER



HIGHLANDER Zero

- Sizes:**
- packed size: 66 cm
 - adjustable from 105–140 cm

Weight:

• 247g

Features:

- Trek cork Comfort grip
- Comfort Padded strap
- 3-sections: Aluminum 7075-T6, Ø 18/16/14 mm
- Twist Lock locking mechanism
- Mini UL Vario basket
- flex carbide tip

art. # 174 23 68-29

ISPO AWARD 2024 WINNER



TREKKING JUNIOR

Let's go... straight into the adventure! Our junior trekking poles are not only made of extremely robust aluminum, they grow with the kids and the pole will stay a loyal companion over many years.

ACCESSORIES

NORDIC WALKING

TREKKING

TRAILRUNNING



TREKKING JUNIOR

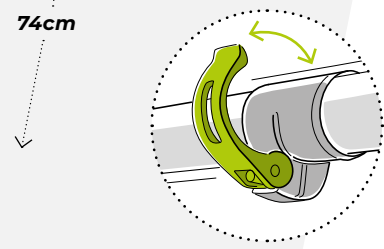
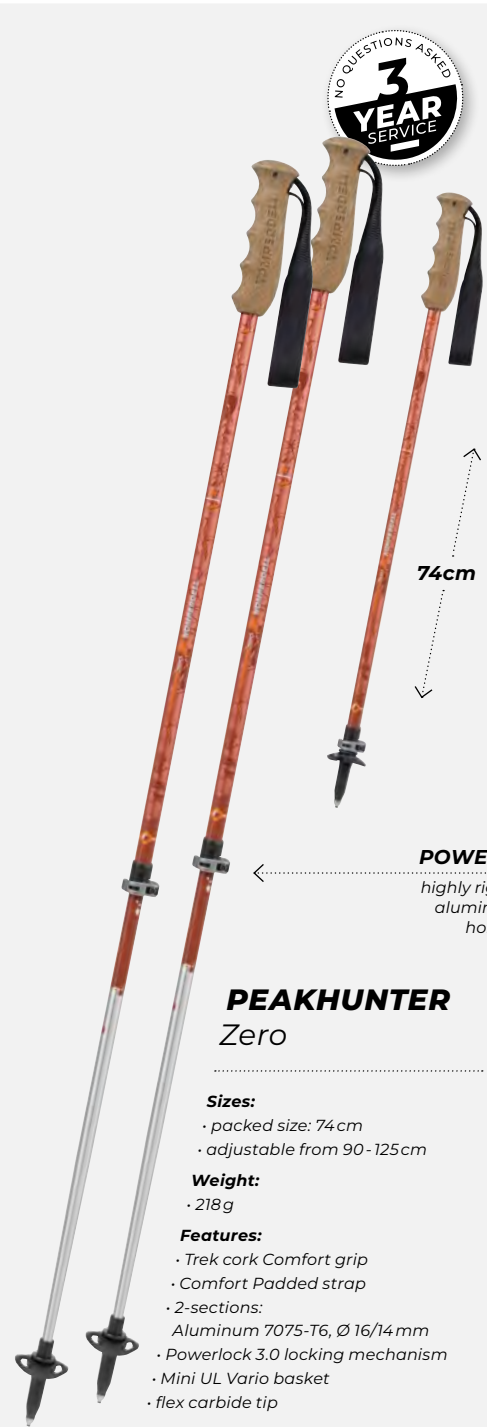

POWERLOCK 3.0
highly rigid, anodized aluminum for max. holding power!

PEAKHUNTER Zero

- Sizes:**
- packed size: 74 cm
 - adjustable from 90 - 125cm
- Weight:**
- 218 g
- Features:**
- Trek cork Comfort grip
 - Comfort Padded strap
 - 2-sections: Aluminum 7075-T6, Ø 16/14 mm
 - Powerlock 3.0 locking mechanism
 - Mini UL Vario basket
 - flex carbide tip

art. # 164 23 19-29
ISPO AWARD 2024 WINNER

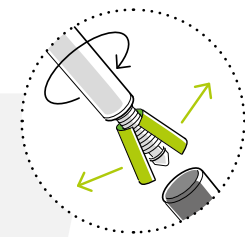

TWISTLOCK
made from glassfiber reinforced plastics



TRAILBLAZER Zero Kids

- Sizes:**
- packed size: 65 cm
 - adjustable from 80 - 105 cm
- Weight:**
- 172 g
- Features:**
- Kids Tour cork grip
 - standard strap
 - 2-sections: upper part: Aluminum 7075-T6, Ø 16 mm lower part: Aluminum 5083, Ø 14 mm
 - Twist Lock locking mechanism
 - Mini UL Vario basket
 - steel tip

art. # 164 23 20-48 green
art. # 164 23 21-14 pink

ISPO AWARD 2024 WINNER



ACCESSORIES

NORDIC WALKING

TREKKING

TRAILRUNNING

TREKKING SINGLE STAFF



Camera Mount System
unscrew the head to mount your camera easily



neoprene quiver included



TRAVEL & WADING Staff FXP Vario

Sizes:
· packed size: 45 cm
· adjustable from 115-135 cm

Weight:
· 262 g

- Features:**
- Traveller 245 grip with Camera Mount System
 - Ergo strap
 - 4-sections: Carbon Composite, Ø 18/16 mm
 - Powerlock 3.0 locking mechanism
 - FXP folding mechanism
 - FXP UL Vario basket
 - flex carbide tip

art. # 196 23 05-10

Outdoor
by ISPO
Outstanding Outdoor
2021 Winner 2021



WALKING Staff FXP Carbon

Sizes:
· packed size: 36 cm (95 cm)
· 85/95/105 cm

Weight:
· 242 g (95 cm)

- Features:**
- Walker comfort cork grip
 - Walker strap
 - 3-sections: Carbon Composite, Ø 16/9 mm
 - FXP folding mechanism
 - Trailstick carbide tip
 - rubber tip protector

art. # 196 23 04-10
Outdoor
by ISPO

Outstanding Outdoor
2021 Winner 2021



Camera Mount System
unscrew the head to mount your camera easily



CAMERA Staff

Sizes:
· packed size: 73 cm
· adjustable from 115-150 cm

Weight:
· 294 g

- Features:**
- Traveller cork 380 grip with Camera Mount System
 - Ergo strap
 - 3-sections: Aluminum 7075-T6, Ø 18/16/14 mm
 - Powerlock 3.0 locking mechanism
 - FXP UL Vario basket
 - flex carbide tip

art. # 176 23 00-10



WALKING SINGLE STAFF

“Much more than just a walking aid. My Komperdell walking staff has, unlike my knee, never let me down. The ergonomically shaped cork grip keeps me grounded and offers a comfortable grip feeling.”

Johann Tuns, nature loving pensioner



WALKING SINGLE STAFF



WALKER Powerlock Compact

Sizes:
 · packed size: 46 cm
 · adjustable from 75–100 cm

Weight:
 · 259 g

Features:
 · Walker comfort cork grip
 · padded Walker strap
 · 3-sections:
 Aluminum 7075-T6, Ø 18/16/14 mm
 · Powerlock 3.0 locking mechanism
 · Mini UL Vario basket
 · flex carbide tip
 · rubber tip protector

art. # 176 23 74-10

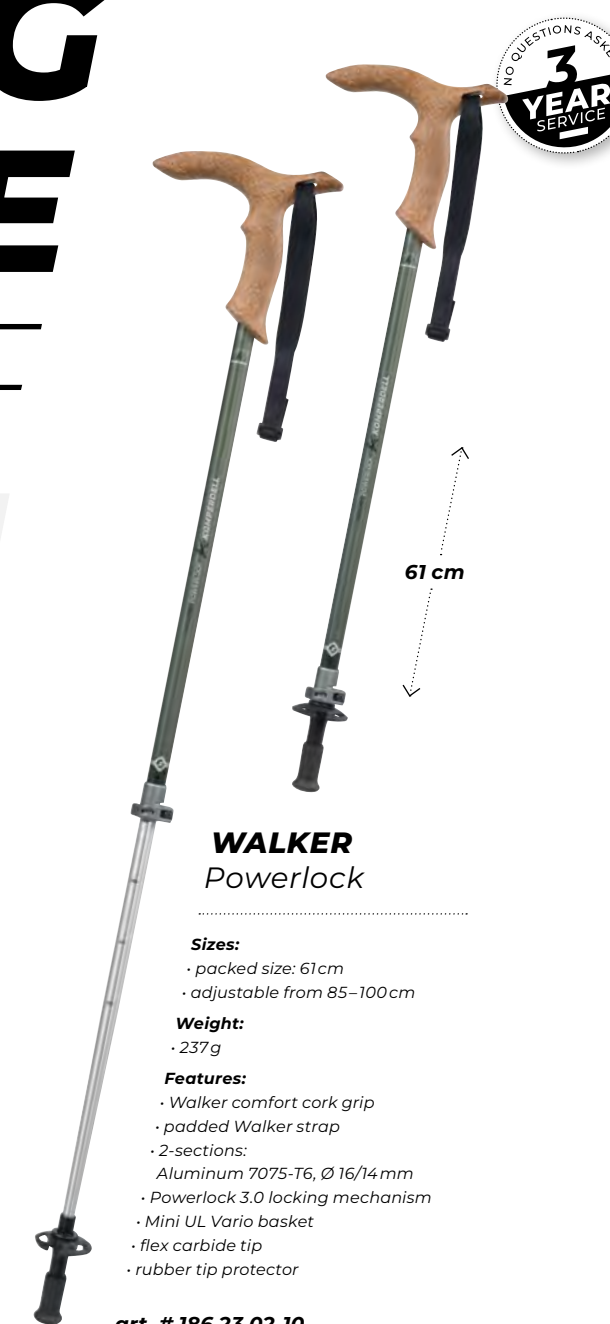

WALKER Powerlock

Sizes:
 · packed size: 61 cm
 · adjustable from 85–100 cm

Weight:
 · 237 g

Features:
 · Walker comfort cork grip
 · padded Walker strap
 · 2-sections:
 Aluminum 7075-T6, Ø 16/14 mm
 · Powerlock 3.0 locking mechanism
 · Mini UL Vario basket
 · flex carbide tip
 · rubber tip protector

art. # 186 23 02-10



NORDIC WALKING CARBON

With our ultra-light Nordic Walking carbon poles, your daily workout becomes pure pleasure.



NORDIC WALKING CARBON



← Sheer bamboo veneer on carbon tube

BAYAMO Carbon

Sizes:
· 105-135cm (in 5cm steps)

Weight:
· 173 g (115 cm)

Features:
· Nordic cork Click-In 2.0 grip
· NW Click-In 2.0 strap
· Carbon Featherlight shaft with Bamboo, Ø 16/9mm
· Trailstick carbide tip
· vulcanised 2-K grip pad

art. # 148 22 21-10

LEVANTE Carbon

Sizes:
· 105-135cm (in 5cm steps)

Weight:
· 182 g (115 cm)

Features:
· Nordic cork Click-In 2.0 grip
· NW Click-In 2.0 strap
· Carbon Featherlight shaft, Ø 16/9mm
· Trailstick carbide tip
· vulcanised 2-K grip pad

■ art. # 148 23 39-10 pure
□ art. # 148 23 39-01 pearl





NORDIC WALKING CARBON

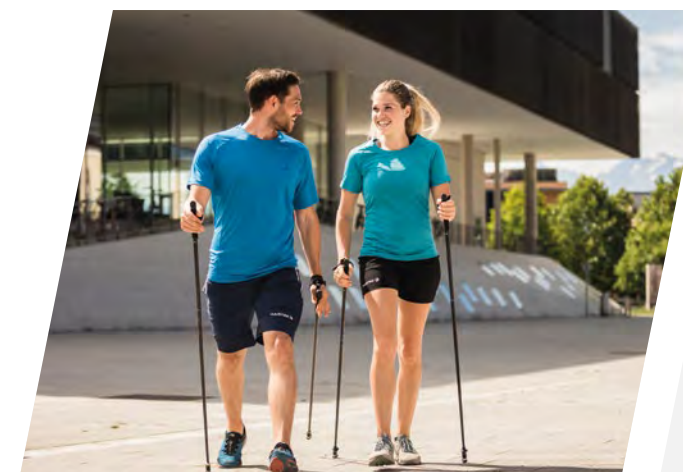

CLICK-IN STRAP

Get in with a click and drop out with a push. Our new click-in system. **It couldn't be easier.**

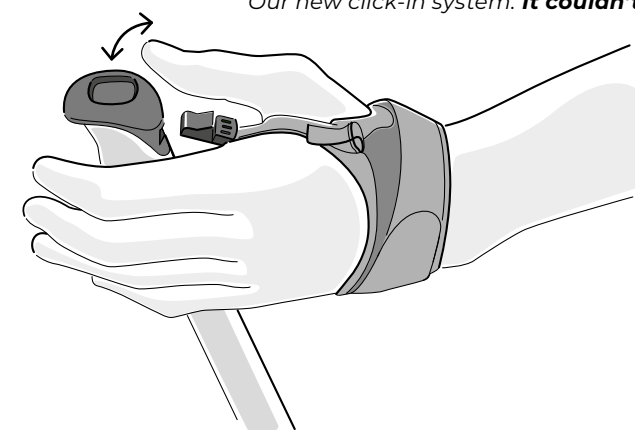

PONIENTE Carbon

Sizes:
· 105–135cm (in 5cm steps)

Weight:
· 196 g (115 cm)

Features:
· Nordic Foam Click-In grip
· NW Click-In 2.0 strap
· Carbon Composite, Ø 16/9 mm
· Trailstick carbide tip
· vulcanised 2-K grip pad

■ art. # 148 23 34-10 pure
□ art. # 148 23 34-01 pearl



FXP TRAVELLER Foldable

Sizes:
· packed size: 41 cm (115 cm)
· 105–135cm (in 10cm steps)

Weight:
· 212 g (115 cm)

Features:
· Nordic Foam Click-In grip
· NW Click-In 2.0 strap
· 3-sections:
Carbon Composite, Ø 16mm
· FXP folding mechanism
· Trailstick carbide tip
· vulcanised 2K grip pad

art. # 194 23 58-10
Outdoor

Outstanding Outdoor
by SPPO
www.spport.com

NORDIC WALKING VARIO



BAYAMO Carbon Vario

Sizes:
 · packed size: 98 cm
 · adjustable from 105 – 125 cm

Weight:
 · 182 g

Features:
 · Nordic cork Click-In 2.0 grip
 · NW Click-In 2.0 strap
 · 2-sections:
 Carbon, Ø 16/14 mm
 · Powerlock 3.0 locking mechanism
 · Trailstick carbide tip
 · vulcanised 2-K grip pad

art. # 175 22 16-10



PONIENTE Carbon Vario

Sizes:
 · packed size: 98 cm
 · adjustable from 105 – 125 cm

Weight:
 · 182 g

Features:
 · Nordic Foam Click-In grip
 · NW Click-In strap 2.0
 · 2-sections:
 Carbon, Ø 16/14 mm
 · Powerlock 3.0 locking mechanism
 · Trailstick carbide tip
 · vulcanised 2-K grip pad

art. # 175 23 62-10

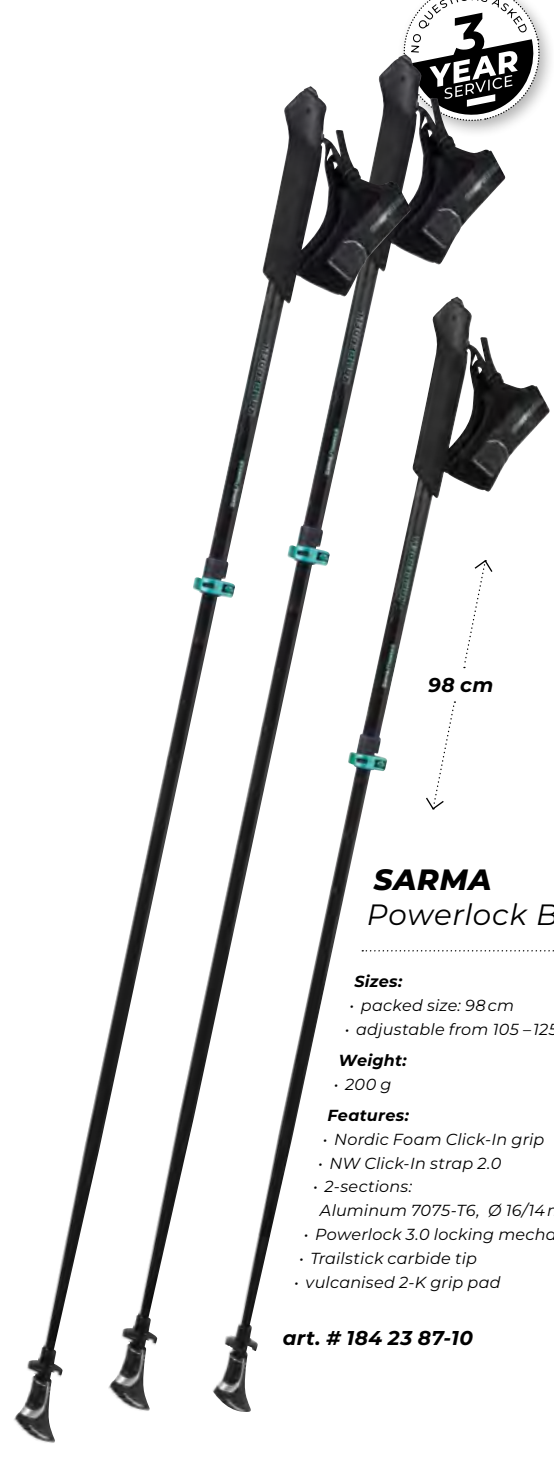

SARMA Powerlock Black

Sizes:
 · packed size: 98 cm
 · adjustable from 105 – 125 cm

Weight:
 · 200 g

Features:
 · Nordic Foam Click-In grip
 · NW Click-In strap 2.0
 · 2-sections:
 Aluminum 7075-T6, Ø 16/14 mm
 · Powerlock 3.0 locking mechanism
 · Trailstick carbide tip
 · vulcanised 2-K grip pad

art. # 184 23 87-10

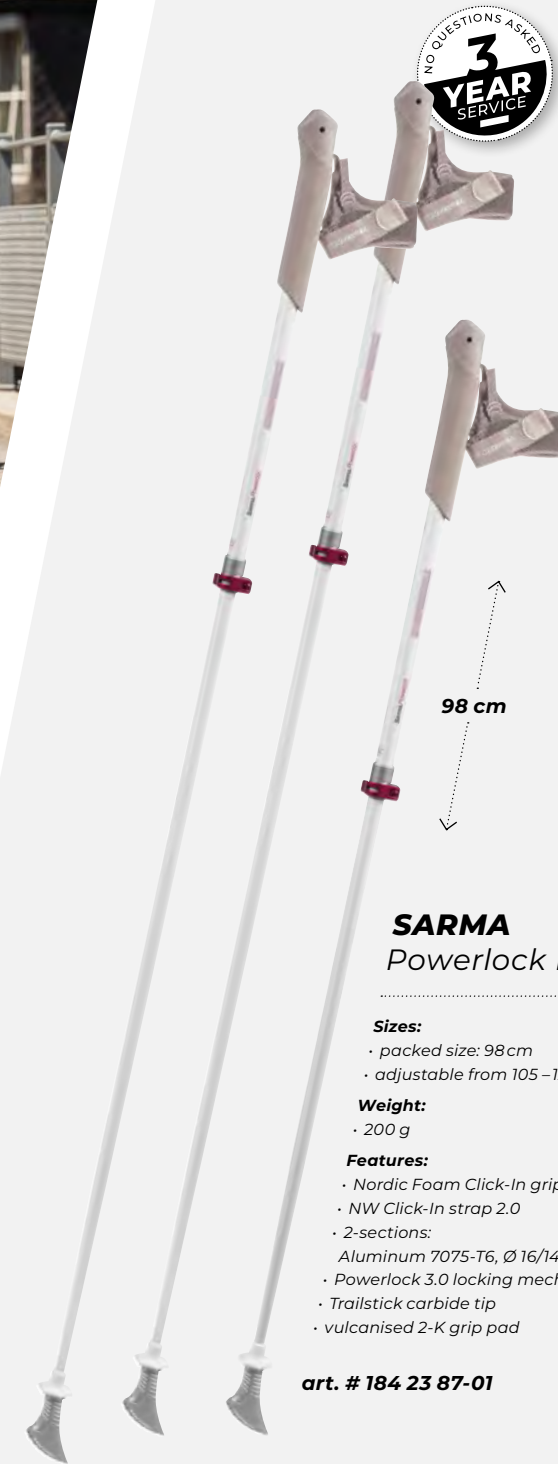

SARMA Powerlock Pearl

Sizes:
 · packed size: 98 cm
 · adjustable from 105 – 125 cm

Weight:
 · 200 g

Features:
 · Nordic Foam Click-In grip
 · NW Click-In strap 2.0
 · 2-sections:
 Aluminum 7075-T6, Ø 16/14 mm
 · Powerlock 3.0 locking mechanism
 · Trailstick carbide tip
 · vulcanised 2-K grip pad

art. # 184 23 87-01



3 YEAR FREE REPAIR SERVICE

→ REPAIRING INSTEAD OF THROWING AWAY

Our commitment to sustainability goes beyond environmentally friendly production methods and recycled materials. We take after-sales responsibility seriously through our unique repair service.

→ INNOVATIVE PIONEERS

We introduced our free 3-year repair service more than 15 years ago, long before the term sustainability became popular. We are still absolute pioneers here today.

→ WORLDWIDE UNIQUE

We repair all telescopic poles no matter what happened – without receipt and no questions-asked. Regardless if it's our customers fault or ours – we are happy to take care of it and contribute to an extended product life-cycle and to protect our environment.



SPARE PARTS

PRE-PACKED



NORDIC WALKING PADS

- art. # 1028-925
- art. # 1029-925



NORDIC WALKING PADS

- art. # 1007-203
- art. # 1007-01



TIP PROTECTOR

- Ø 8 mm
- art. # 192-925
- Ø 12 mm
- art. # 190-925



PACK-AWAY TIP

- Ø 8 mm
- art. # 162-925
- Ø 12 mm
- art. # 161-925



ERGO STRAP

art. # 7026-925



NORDIC SPEED CLICK IN 2.0 STRAP

Sizes:
· S-XL

art. # 7017-925



NORDIC WALKING CLICK IN 2.0 STRAP

Sizes:
· XS-L

art. # 7019-925



NORDIC WALKING CLICK IN 2.0 STRAP

Sizes:
· XS-XL

art. # 7014-925



TRAIL CLICK IN 2.1 STRAP

Sizes:
· XS-XL

art. # 7018-925



VARIO SUMMER BASKET

art. # 9356-925



RACE BASKET

art. # 9352-925



RACE BASKET EXTRA SMALL

art. # 9379-925



TRAILSTICK BASKET

art. # 1022-925



VARIO WINTER BASKET

art. # 9364-925



VARIO WINTER BASKET XL

art. # 9912-925



VARIO DEEP POWDER BASKET

art. # 9908-925



MINI UL BASKET

art. # 9942-925



LARGE UL ICE-FLEX BASKET

art. # 9950-925



REGULAR UL ICE-FLEX BASKET

art. # 9949-925



REGULAR UL ICE-FLEX FXP BASKET

art. # 9952-925



REGULAR UL BASKET

art. # 9948-925



MINI UL VARIO BASKET

art. # 9943-925



REGULAR UL VARIO BASKET

art. # 9944-925



LARGE UL VARIO BASKET

art. # 9951-925



LARGE UL VARIO BASKET

art. # 9953-925

SPARE PARTS

PRE-PACKED TRAILRUNNING



FXP Tape

- art. # 8292-925 Erlkönig Original
- art. # 8280-925 Erlkönig Green
- art. # 8282-925 Erlkönig Pink
- art. # 8285-925 Black Pink Striped
- art. # 8288-925 Solid Pink
- art. # 8286-925 Black Green Striped
- art. # 8289-925 Solid Green
- art. # 8287-925 Black Blue Striped
- art. # 8290-925 Solid Blue

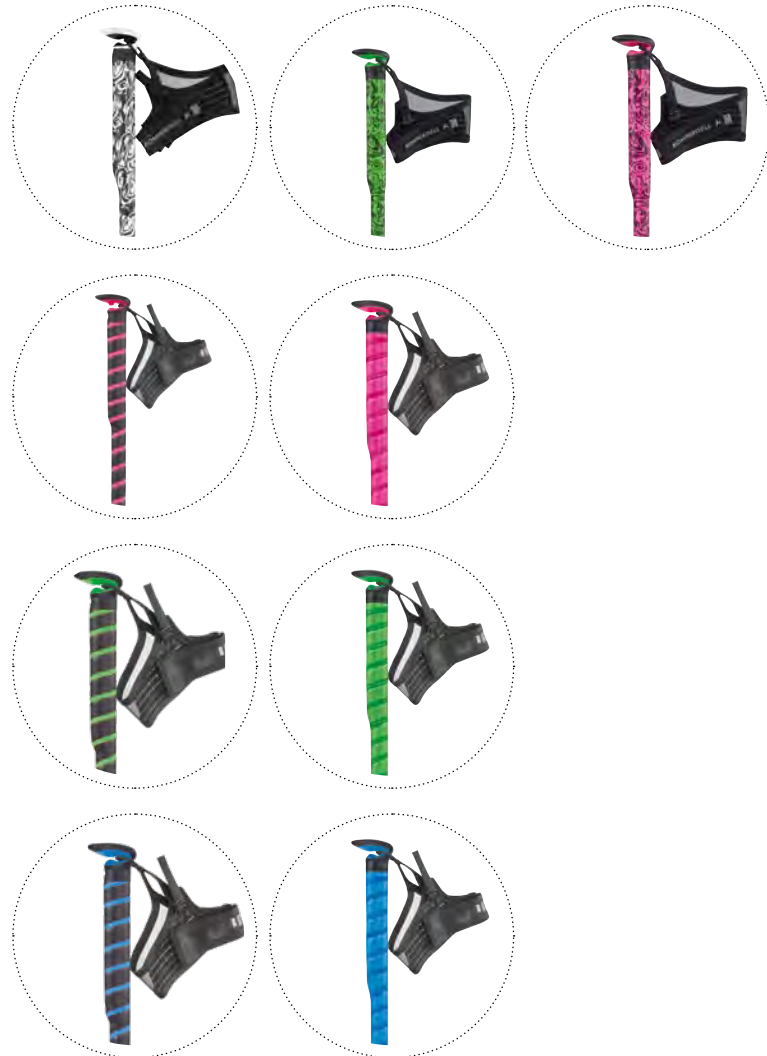

FLY STRAP SPORT

Sizes:
· XS - XL

art. # 7040-925



FLY STRAP LOOP

Sizes:
· One Size

art. # 7031-925

POS MATERIAL

POLE PACKAGING



POLE DISPLAY
made of solid wood

for 16 pairs of poles (without poles)

art. # 6002-25

for 8 pairs of poles (without poles)

art. # 6001-25



BEACHFLAGS

- Features:
- padded transportation bag
 - base plate 18 x 30 x 0,6 cm
 - for indoor use or bolt
 - for outdoor use

total height 250 cm

art. # 34-48

total height 450 cm

art. # 29-48



LOT BOX Zero Waste – Recycling

- Features:**
- 59x38.5x68 cm (measured without sticks)
 - In-store display for 15 pairs
 - Telescopic or fixed length poles
 - made of robust cardboard
 - ideal for every shop
 - with recycling compartment for correct disposal

art. # 61-999



TEAM WEAR HOODY Men

- Sizes:**
- S-XXL
- Features:**
- individualization with own name or logo optional
 - front zip

art. # K7801-208 neon green



TEAM WEAR HOODY Women

- Sizes:**
- S-XXL
- Features:**
- individualization with own name or logo optional
 - front zip

art. # K6801-209 berry

BUFF BEANIE

- Features:**
- Reversible: two designs in one product.
 - Ultra-Stretch Technology: 4-way stretch for best fit and maximum comfort.
 - legendary comfort & top performance: recycled fiber, UV protection, improved elasticity.

art. # 6655-48 green

art. # 6656-14 pink



BUFF MULTIFUNCTIONAL SCARF

- Features:**
- The multifunctional classic: flexible, recycled and providing UV-Protection
 - Ultra-Stretch-Technology: 4-way-stretch for the best fit and comfort
 - Enjoy multifunctionality: choose your style of wearing!

art. # 6659-48 green

art. # 6660-14 pink

BUFF HEADBAND

- Features:**
- wide design for more comfort and protection
 - Ultra-Stretch-Technology: 4-Way-Stretch for the best fit and comfort
 - Recycled materials for a better planet

art. # 6653-48 green

art. # 6654-14 pink

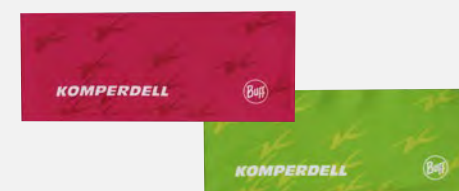

KOMPERDELL.COM



HEADQUARTERS MONDSEE

KOMPERDELL GmbH

Wagnermühle 30 | 5310 Mondsee | Austria
T 0043 6232 4201-0 | sales@komperdell.com
komperdell.com

DISTRIBUTION NORTH AMERICA

CAMARO USA, LLC

1021 | 39th Avenue SE Puyallup | WA 98374 | USA
T +1 253-867-57 35 | sales-usa@camaro.at
komperdell.com



KOMPERDELL